

水栓取付穴

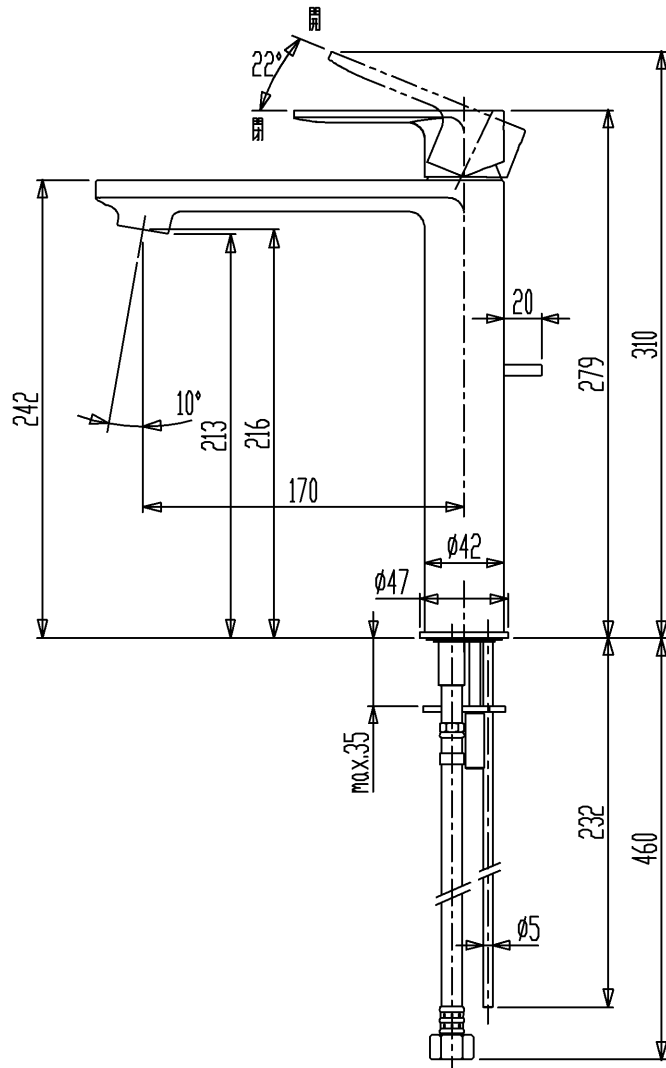
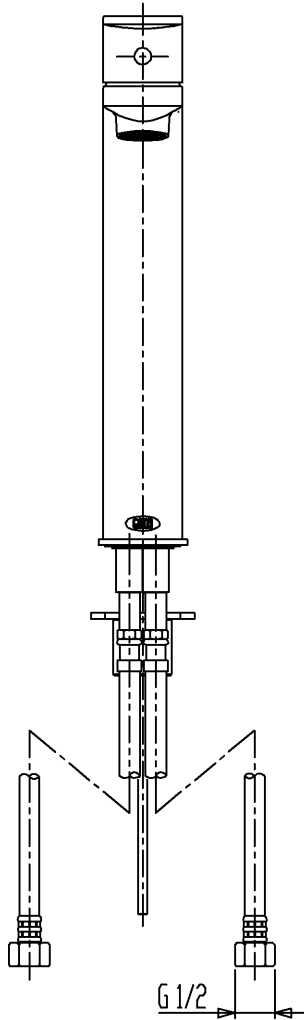

セラトレーディング株式会社			単位 mm	名称 C1 湯水混合水栓
製図 福田	検図 中村	日付 17.09.06	尺度 1 : 4	品番 CET3522S
備考 (JIS)				団番 CET3522S